

forsterthermfix® vario
forsterthermfix® varioHI
forsterthermfix® light



$U_f > 0.49 \text{ W/(m}^2\text{K)}$



EI30-EI90/E30-E90/
EW30-EW60



RC 1-3



FB4 NS



forsterthermfix® vario
forsterthermfix® varioHI

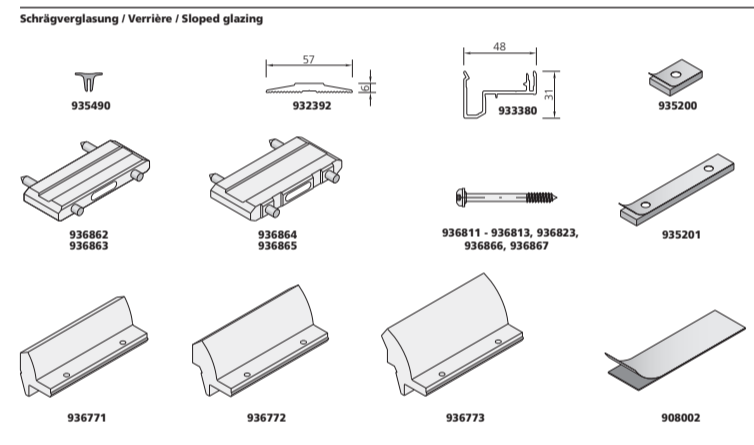
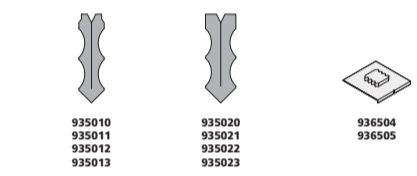
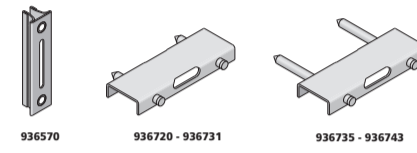
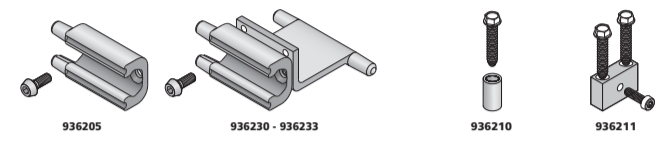
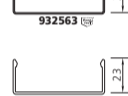
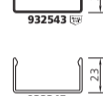
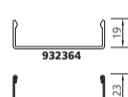
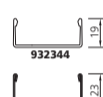
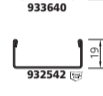
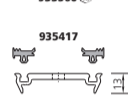
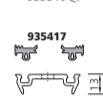
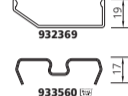
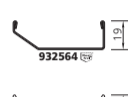
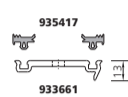
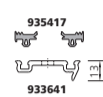
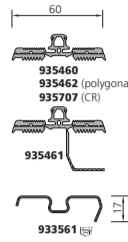
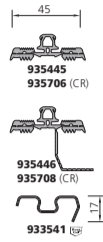
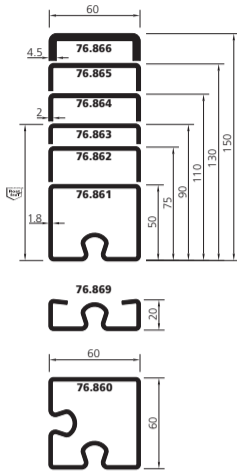
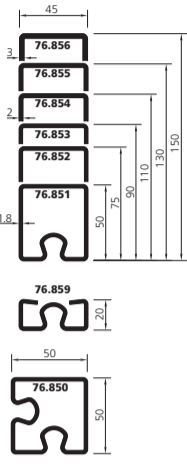

forsterthermfix® light

